

06230001

MAX

Grifo monomando empotrado para lavabo

- Cuerpo empotrado indivisible con amortiguadores acústicos
- Junta antihumedad
- Caño de 177 mm



Acabado Cromo



Referencia del cartucho: 29902801

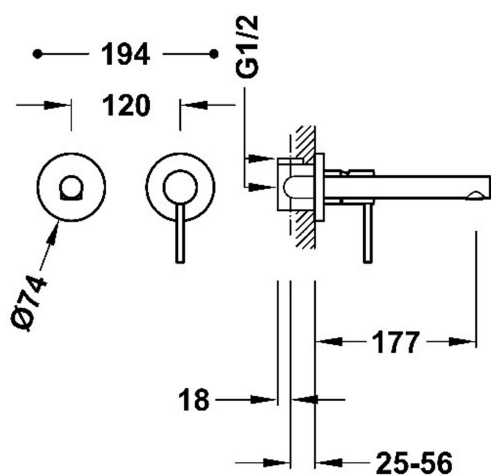

06230002

MAX

Grifo monomando empotrado para lavabo

- Cuerpo empotrado indivisible con amortiguadores acústicos
- Junta antihumedad
- Caño de 237 mm



Acabado Cromo



Referencia del cartucho: 29902801

